

Guidance and Control System for Platoon of Autonomous Mobile Robots

Vesna Antoska-Knights¹, Zoran Gacovski², Stojce Deskovski³

Abstract — This paper presents a concept of platoon movement of autonomous vehicles (smart cars). Autonomous vehicles have Adaptive or Advanced cruise control (ACC) system also called Intelligent cruise control (ICC) or Adaptive Intelligent cruise control (AICC) system. These vehicles are suitable to follow other vehicles on desired distance and to be organized in platoons. To be able to do research to the control and stability of an AGV (Automated Guided Vehicles) string, a car-following model is being determined. To do this, first a single vehicle is modelled and since all cars in the platoon have the same dynamics, the single vehicle model is copied ten times to form model of platoon (string) with ten vehicles. To control this string, equal PID controllers are applied to all vehicles, except the leading vehicle. For control of vehicle with nonlinear dynamics combination of feedforward control and feedback control approach is used. For simulation and analysis of vehicle and platoon of vehicles Matlab/Simulink models are designed.

Keywords — Platoon of vehicles, Smart cars, Adaptive cruise control (ACC), Intelligent transportation system, String Stability.

I. INTRODUCTION

Grouping vehicles into platoons is a method of increasing the capacity of roads. An automated highway system is a proposed technology for doing this. Platoons decrease the distances between cars using electronic, and possibly mechanical, coupling. This capability would allow many cars to accelerate or brake simultaneously. Instead of waiting after a traffic light changes to green for drivers ahead to react, a synchronized platoon would move as one, allowing up to a fivefold increase in traffic throughput if spacing is diminished that much. This system also allows for a closer headway between vehicles by eliminating reacting distance needed for human reaction.

Today – this field is widely explored and implemented in practice. SARTRE is a European Commission FP7 co-funded project [1]. It is built on existing results and experience and analyse the feasibility of vehicle platoons (consisting of both trucks/busses and passenger cars) as a realistic future transport and mobility concept. Crawford et al. [2] examine the sensory combination (GPS, cameras, scanners) to fulfill the task of following. Other authors (Halle et al. [4]) consider the car platoons as collaborative multi-agent system. They propose a hierarchical architecture based on three layers (guidance layer, management layer and traffic control layer) which can be used for simulating a centralized platoon (where

a head vehicle-agent coordinates other vehicle-agents by applying its coordination rule) or a decentralized platoon (where the platoon is considered as a team of vehicle-agents trying to maintain the platoon).

This paper is organized as follows: Section 2 presents deriving of dynamic vehicle model and its linearization. Section 3 presents concept of vehicle control system. Section 4 is reserved for vehicle platoon modeling and control. Section 5 discusses simulation results given using Matlab/Simulink models of the vehicle and platoon of vehicles.

II. DYNAMIC VEHICLE MODEL

In this section we present mathematical model of longitudinal motion of the vehicle which is relevant for platoon modeling and control. For modeling in this case it can be used two coordinate systems (see Fig. 1): vehicle-fixed or body-fixed coordinate system, $B(C; x, z)$, and Earth-fixed coordinate system, $E(O; x_0, z_0)$. Velocity of the vehicle has components along x and z axes, i.e. $\mathbf{V}_B = [u, v]^T$. Fig. 1 shows free body diagram of a vehicle with mass m . Vehicle is inclined upon angle θ with respect to horizontal plane (slope of the road).

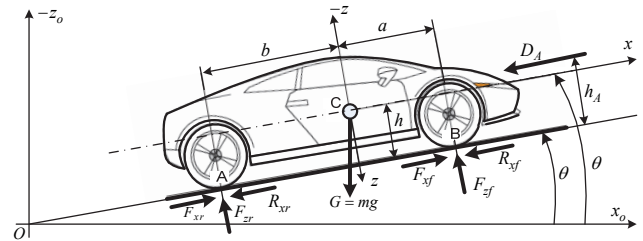

Fig. 1. Forces acting on a vehicle

The diagram includes the significant forces acting on the vehicle: g is the gravitational constant; D_A is the aerodynamic force; $G=mg$ is the weight of the vehicle; F_x is the tractive force; R_x is the rolling-resistance force; and ma_x , an equivalent inertial force, acts at the center of mass, C . The subscripts f and r refer to the front (at B) and rear (at A) tire-reaction forces, respectively.

Application of Newton's second law for the x and z directions gives [8]:

$$m\dot{u} = F_{xr} + F_{xf} - G \sin \theta - R_{xr} - R_{xf} - D_A \quad (1)$$

$$m\dot{v} = 0 = G \cos \theta - F_{zf} - F_{zr} \quad (2)$$

The aerodynamic-drag force depends on the relative velocity between the vehicle and the surrounding air and is given by the semi-empirical relationship:

$$D_A = \frac{1}{2} \rho C_d A_f (u + u_w)^2 = \frac{1}{2} C_{air} (u + u_w)^2 \quad (3)$$

¹Vesna Antoska-Knights is with Faculty of Technol. and Technic. Sciences – Veles, Macedonia, E-mail: vesna_antoska@gmail.com

²Zoran Gacovski is with the European University-Skopje, Macedonia, E-mail: zgacovski@yahoo.com

³Stojce Deskovski is with Technical Faculty-Bitola, Macedonia, E-mail: stojce.deskovski@gmail.com

where ρ is the air density ($= 1.202 \text{ kg/m}^3$ at an altitude of 200 m), C_d is the drag coefficient, A_f is the frontal area of the vehicle, u is the vehicle-forward velocity, and u_w is the wind velocity (i.e., positive for a headwind and negative for a tailwind). The drag coefficient for vehicles ranges from about 0.2 (i.e., streamlined passenger vehicles with underbody cover) to 1.5 (i.e., trucks); 0.4 is a typical value for passenger cars [8].

The rolling resistance arises due to the work of deformation on the tire and the road surface, and it is roughly proportional to the normal force on the tire:

$$R_x = R_{xf} + R_{xr} = f_r (F_{zf} + F_{zr}) = f_r mg \cos \theta \quad (4)$$

where f_r is the rolling-resistance coefficient in the range of about 0.01 to 0.4, with 0.015 as a typical value for passenger vehicles.

For farther consideration we use equation (1). Equation (1) is nonlinear in the forward velocity, $u(t)$ but otherwise is a simple dynamic system: it only has one state variable. So, what are the main challenges incruise-control design problems? The difficulties arise mainly from two factors: (1) plant uncertainty due to change of vehicle weight, and (2) external disturbances due to road grade. Thus, a good cruise-control algorithm must work well under these uncertainties.

Equation (1), using (3) and (4) can be rewritten:

$$m\dot{u} = F_x - mg \sin \theta - f_r mg \cos \theta - \frac{1}{2} C_{air} (u + u_w)^2 \quad (5)$$

where $C_{air} = \rho A_f C_d$ is a constant.

Equation (5) is used for creation of nonlinear Simulink model of the vehicle in the platoon.

For analysis of the dynamics and stability of the vehicle and string stability of the platoon we need a linearized model of the vehicle.

In vector-matrix form the linearized system gets form [3]:

$$\begin{bmatrix} \Delta \dot{x} \\ \Delta \dot{u} \end{bmatrix} = \begin{bmatrix} 0 & 1 \\ 0 & -\frac{1}{Km} \end{bmatrix} \begin{bmatrix} \Delta x \\ \Delta u \end{bmatrix} + \begin{bmatrix} 0 \\ \frac{1}{m} \end{bmatrix} \Delta F_x + \begin{bmatrix} 0 \\ \frac{1}{m} \end{bmatrix} d \quad (6)$$

III. VEHICLE CONTROL SYSTEM

In cases when the real vehicle is with nonlinear dynamics (in our case equation (5) for longitudinal dynamics) it is very useful to implement combination of feed-forward control and feedback control approach, presented on Fig. 3.

The feed-forward control is formed on the *inverse model* of the object and on the generator of *nominal trajectories* which generates the desired trajectory $\mathbf{x}^o(t)$. This desired trajectory is based on the previously prepared data or from the process of operation of the system based on the measured data. For realization of this trajectory it is necessary that regulator in feedback is present, which will generate the needed control $\Delta \mathbf{u}(t)$ for elimination of the error of the trajectory of the object from the desired trajectory. This provides stabilisation of the control process of the object.

The sum control $\mathbf{u}(t)$ of the moving object from Fig. 3, when the linear regulator is formed by the matrix $\mathbf{K}(t)$, is given with the following relation:

$$\mathbf{u}(t) = \mathbf{u}^o(t) + \Delta \mathbf{u}(t) = \mathbf{u}^o(t) - \mathbf{K}(t) \Delta \mathbf{x}(t) = \mathbf{u}^o(t) - \mathbf{K}(t) [\mathbf{x}(t) - \mathbf{x}^o(t)] \quad (7)$$

The synthesis of the control law given by equation (7) is performed in two steps. In the first step the nominal control $\mathbf{u}^o(t)$ is determined under assumption of ideal conditions i.e. when no disturbances are present.

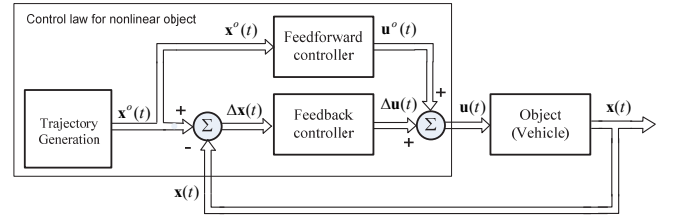

Fig. 2. Concept of feed-forward and feedback control system of nonlinear object

According to the described concept (Fig. 2), the control laws for vehicles can be developed. In this paper feed-forward control is determined based on (6) for nominal tractive force which present nominal control.

Feedback controller, which provides stabilization of the object around the nominal trajectory, can be designed using linearized model. Under assumption that the dynamic behavior of the object with respect to the nominal trajectory is linear, as described with (6), for the control $\Delta \mathbf{u}(t)$, we can apply methods for synthesis developed for linear systems: PID controller design, Linear Quadratic Regulator (LQR), methods for pole placement, adaptive optimal control etc.[3].

In this paper PID control design approach is used and PID feedback controller is obtained based on linear model of the vehicle derived above with parameters determined using numerical values. For simulation and testing of vehicle dynamics and vehicle control system Simulink model is developed which is shown in Fig. 3.

Module reference inputs, generate reference acceleration a_o , velocity v_o , and position x_o , similar like the leader of the platoon. These signals go to the PID controller where are processed according to:

$$u = \Delta F_x = K_p (x_o - x) + \frac{K_I}{s} (x_o - x) + K_D (v_o - v) \quad (8)$$

where K_p , K_I , and K_D are proportional, integral and derivative gains of the controller, a , v and x are real acceleration, velocity and position of the vehicle.

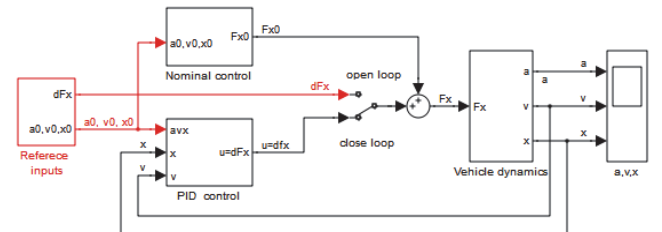

Fig. 3. Simulink diagram for the vehicle control

Module *Nominal control*, Fig. 3, consists of equation (6), and module *Vehicle dynamics*, which is based on full nonlinear model, equation (5).

Simulink model in Fig. 3 can be used for open loop, and closed loop simulation of the controlled vehicle.

IV. CONTROL OF A PLATOON OF VEHICLES

Platooning requires another level of control beyond individual vehicles. Two fundamentally different approaches to platooning have been suggested: (1) point-following control, in which each vehicle is assigned a particular moving slot on the highway and maintains that position [5]; and (2) vehicle-following control, in which each vehicle in the platoon regulates its position relative to the vehicle in front of it based on information about the lead vehicle motion [6] and locally measured variables (i.e., its own motion and headway to the vehicle in front). In this paper we discuss the vehicle-following control approach, which is the focus of most current research and development work in the area [8].

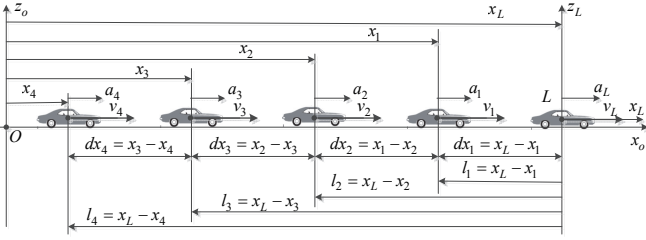

Fig. 4. Configuration of platoon with 5 vehicles

Movement of the vehicles we observe in the inertial (or absolute) coordinate system $G(O; x_o, y_o)$ which is fixed to the road with origin in the starting point, O (Fig. 4). Positions, x_i , velocities, $v_i = \dot{x}_i$, and accelerations, $a_i = \dot{v}_i$, $i = L, 1, 2, 3, 4$, measured with respect to $G(O; x_o, y_o)$, are absolute quantities. Coordinate system $L(L; x_L, y_L)$, see Fig. 4, is fixed to the vehicle-leader with origin in the center of its mass. Relative position, velocity and acceleration of the vehicles with respect to $L(L; x_L, y_L)$ are denoted as: $l_i = x_L - x_i$, $v_{ri} = v_L - v_i$, $a_{ri} = a_L - a_i$, $i = 1, 2, 3, 4$ respectively. Distances between vehicles are denoted as $dx_i = x_{i-1} - x_i$, $i = L, 1, 2, 3, 4$, and relative velocities and accelerations of the vehicles with respect to vehicle in front of them are respectively:

$$dv_i = v_{i-1} - v_i = \dot{x}_{i-1} - \dot{x}_i,$$

$$da_i = a_{i-1} - a_i = \ddot{x}_{i-1} - \ddot{x}_i, \quad i = L, 1, 2, 3, 4.$$

Based on Fig. 3, and mathematical model of individual vehicle together with its own control system - Matlab-Simulink model of the platoon of 10 vehicles is developed. The main Simulink diagram of this model is shown in Fig. 5. In this model each vehicle gets information about acceleration, velocity and position of the previous vehicle, and also gets the same information about vehicle-leader.

Using vehicle model (5), if $\theta = 0$ and $V_w = 0$, we can find acceleration of the vehicle in this form:

$$\dot{u} = a = \frac{1}{m}(F_x - f_r mg - \frac{1}{2} C_{air} u^2), \quad F_x = \Delta F_x + F_{x0} \quad (9)$$

Substituting (8) in (9) we can find acceleration written for i -th vehicle:

$$a_i = \frac{1}{m} [K_{p_i}(x_{i-1} - x_i - hd_i) + \frac{K_{f_i}}{s}(x_{i-1} - x_i - hd_i) + K_{D_i}(v_{i-1} - v_i) + F_{x0} - f_r mg - \frac{1}{2} C_{air} u_i^2], \quad (10)$$

where hd_i is constant distance between $i-1$ -th and i -th vehicles. Deriving (9a) we can get jerk which act on the i -th vehicle (F_{x0} and $f_r mg$ are constant), and using relations:

$$\dot{x}_i = v_i, \quad (11)$$

$$\dot{v}_i = a_i, \quad (12)$$

we can find:

$$\dot{a}_i = \frac{1}{m} [K_{f_i}(x_{i-1} - x_i - hd_i) + K_{p_i}(v_{i-1} - v_i) + K_{D_i}(a_{i-1} - a_i) - C_{air} u^2 a_i]. \quad (13)$$

Equations (11), (12) and (13) represent linear state space model of the i -th vehicle in the platoon. Variables x_{i-1} , v_{i-1} , and $a_{i-1} - a_i$ in equation (13) are input variables for the i -th vehicle and they are position, velocity and acceleration of the previous, or $i-1$ -th, vehicle.

Equations (11)-(13) can be used for generation state space model of string of several vehicles. This model is useful for stability analysis of the string using techniques of linear control theory. Here we form model for string of three vehicles: vehicle-leader, and two vehicles-followers. Outputs of the vehicle-leader generate input variables, x_L , v_L , and a_L , for the first vehicle in the string. Other two vehicles are described with equations obtained from (11-13) if we put $i=1, 2$, and for $i=1 \rightarrow i-1=L$ (L -index for vehicle - leader).

For a platoon of vehicles, beside individual vehicle stability, is defined *string stability* of the platoon [8, 9]. If the preceding vehicle is accelerating or decelerating, then the spacing error could be nonzero; we must ensure that the spacing error attenuates as it propagates along the string of vehicles because it propagates upstream toward last vehicle.

Linear model of the string of three vehicles (vehicle-leader and two vehicles-followers) in vector-matrix form is given with equation (14) and (15):

$$\begin{bmatrix} \dot{x}_1 \\ \dot{dx}_2 \\ \dot{v}_1 \\ \dot{a}_1 \\ \dot{a}_2 \end{bmatrix} = \begin{bmatrix} 0 & 0 & 1 & 0 & 0 & 0 \\ 0 & 0 & 1 & -1 & 0 & 0 \\ 0 & 0 & 0 & 0 & 1 & 0 \\ 0 & 0 & 0 & 0 & 0 & 1 \\ \frac{-K_{f1}}{m} & 0 & \frac{-K_{p1}}{m} & 0 & \frac{-K_{D1} - C_{air} u^2}{m} & 0 \\ 0 & \frac{K_{f2}}{m} & \frac{K_{p2}}{m} & \frac{-K_{p2}}{m} & \frac{K_{D2}}{m} & \frac{-K_{D2} - C_{air} u^2}{m} \end{bmatrix} \begin{bmatrix} x_1 \\ dx_2 \\ v_1 \\ a_1 \\ a_2 \end{bmatrix} + \begin{bmatrix} 0 & 0 & 0 \\ 0 & 0 & 0 \\ 0 & 0 & 0 \\ 0 & 0 & 0 \\ \frac{K_{f1}}{m} & \frac{K_{p1}}{m} & \frac{K_{D1}}{m} \\ 0 & 0 & 0 \end{bmatrix} \begin{bmatrix} x_L \\ v_L \\ a_L \end{bmatrix} + \begin{bmatrix} 0 & 0 \\ 0 & 0 \\ 0 & 0 \\ 0 & 0 \\ \frac{-K_{f1}}{m} & 0 \\ 0 & \frac{-K_{f2}}{m} \end{bmatrix} \begin{bmatrix} hd_1 \\ hd_2 \end{bmatrix} \quad (14)$$

If we select for outputs distance between vehicles, dx_2 , and velocities v_1 and v_2 , we can form output vector, $y = [dx_2 \ v_1 \ v_2]^T$, as:

$$y = \begin{bmatrix} dx_2 \\ v_1 \\ v_2 \end{bmatrix} = \begin{bmatrix} 0 & 1 & 0 & 0 & 0 & 0 \\ 0 & 0 & 1 & 0 & 0 & 0 \\ 0 & 0 & 0 & 1 & 0 & 0 \end{bmatrix} \mathbf{x} + \begin{bmatrix} 0 & 0 & 0 \\ 0 & 0 & 0 \\ 0 & 0 & 0 \end{bmatrix} \begin{bmatrix} x_L \\ v_L \\ a_L \end{bmatrix} \quad (15)$$

Stability analysis of the individual vehicle and platoon of vehicles can be made in Matlab using their linear models and compute poles of the system or find gain and phase margins with help of Nyquist plot. For example, for string of two vehicles-followers, using model (14) and parameters, we can find eigenvalues or poles, p_1, \dots, p_6 :

-1.2690, -1.2690, -0.5306, -0.5306, -0.0149, -0.0149

which are real and negative, and system is stable. These results are given for parameters of the vehicles and PID controllers given in Section V.

V. SIMULATION RESULTS

We have simulated a platoon with 10 vehicles. Fig. 5 presents basic SIMULINK block diagram for the platoon model. All vehicles are the same with parameters. Parameters used in simulations are: $m=1000$ kg mass of the vehicles, $\rho = 1.2$ kg/m³ - air density, $A_f=1.2$ m² - frontal area of the vehicle, $C_d=0.5$; % drag coefficient, $f_r=0.01$ - rolling resistance coefficient, $g=9.81$ - gravity acceleration, $C_{air} = 0.5 \cdot C_d \cdot A_f \cdot \rho_0 = 0.234$ - constant, $F_{roll} = f_r \cdot mg \cos \theta = 73.6$ - rolling resistance force, $u=20$ m/s - velocity of the vehicles. Desired distances among vehicles are $dx_{i0}=50$ m, Parameters of PID controllers are: $K_{P_i}=700$, $K_{I_i}=10$, and $K_{D_i}=1800$. Vehicle-Leader generates acceleration, velocity and position which are shown in the pictures below.

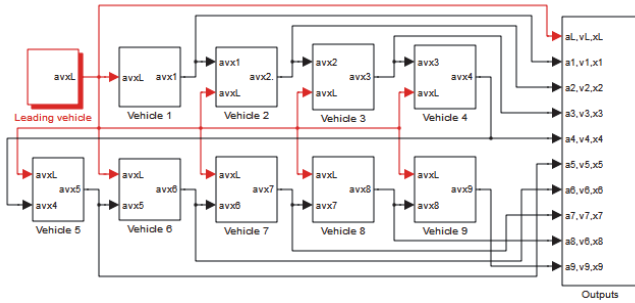

Fig. 5. Matlab/Simulink model of the platoon of 10 vehicles

Fig. 6 shows velocity profile of the vehicle leader and responses of vehicles – followers.

Fig. 7 shows distance errors between vehicles for the same inputs. Fig. 8 shows positions of the vehicles in the platoon when each vehicle gets information for acceleration, velocity and position only for previous vehicle.

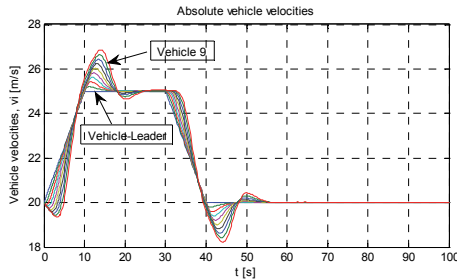

Fig. 6. Trapezoidal change of vehicle-leader velocity and responses of vehicles in the platoon

In this situation errors in positions between vehicles are smaller. It is known in the literature that information for vehicle-leader movement and inter-vehicle communication influence to better control and string stability of the platoon.

VI. CONCLUSIONS AND FUTURE WORK

In this paper we have developed a nonlinear and linearized model of the longitudinal motion of the vehicle. Feedforward control and feedback PID control approach is applied to design vehicle controller. Using this vehicle model with its

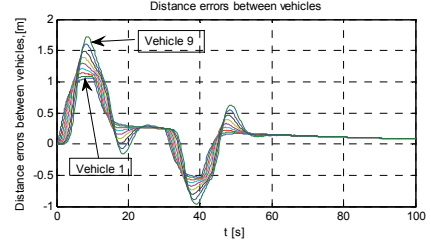

Fig. 7. Distance errors between vehicles

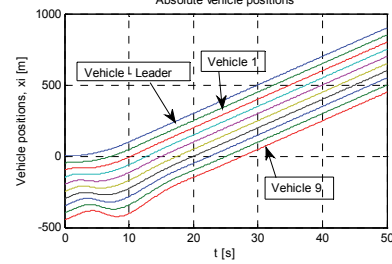

Fig. 8. Positions of the vehicles

designated control system model of platoon with ten vehicles is developed. In this model vehicles can get information for acceleration, velocity and position for previous vehicle and for movement of the vehicle –leader. String stability of the platoon is discussed and transfer function of the string useful for stability analysis is presented. Based on the developed models Matlab/Simulink models are created which can be used for simulation and performance analysis of the vehicle dynamics and platoon's control system.

In future work, we plan to develop more accurate models of the vehicles and platoons. We plan to design and test different than PID control laws, for example LQR and Fuzzy logic control. Realization using different sensors and wireless communication among vehicles will be our interest in future.

REFERENCES

- [1] E. Chan, P. Gilhead, P. Jelinek, and P.Krejčí, "SARTRE Cooperative Control of Fully Automated Platoon Vehicles", *18th World Congress on Intelligent Transport Systems*, USA, 2011.
- [2] S.A. Crawford, "Performance Evaluations of Sensor Combinations for Mobile Platoon Control", Univ. of Calgary, Rep. 20213, 2005.
- [3] G.F. Franklin, J.D. Powell, and A. Emami-Naeini; *Feedback Control of Dynamic Systems*, fourth edition, 2002.
- [4] B.A. Güvenç, and E. Kural, "Adaptive Cruise Control Simulator. A Low-Cost Multiple-driver in-the-loop Simulator", Istanbul Technical University, 2006.
- [5] S. Halle, and B. Chaib-Draa, "A Collaborative Driving System Based on Multi Agent Modelling and Simulations", *Transportation Research Part C: Emerging Technologies*, pp. 320-345.
- [6] S. Sheikholeslam, and CA. Desoer, "Longitudinal Control of a Platoon of Vehicles. I: Linear Model", Institute of Transportation Studies, University of California at Berkeley, 1989.
- [7] J. Zhong, "PID Controller Tuning: A Short Tutorial", Mechanical Engineering, Purdue University, 2006.
- [8] A. Galip Ulsoy, H. Peng, and M. Cakmakçı, *Automotive Control Systems*, Cambridge University Press, 2012.
- [9] C.-Y. Liang, and H. Peng, "String Stability Analysis of Adaptive Cruise Controlled Vehicles", <http://www-personal.umich.edu/~hpeng/JSME 2000.pdf>.